

Bateria 12V

605203 **TBLI12152**

Voltaje 12V (1.5AH)
Para Utdli228120



Cargador De Taladro

216740 **UTCLI12071**

Voltaje 12V



Batería Litio Ion 20v - 2.0Ah

605210 **TFBLI20011**

Litio 2.0 Ah
Indicador Led De Carga



Bateria Litio De 12V

605202 **TBLI12151**

Voltaje 12V (1.5AH)
Para Utdli1211



Cargador Usb-A Para Celulares Y Otros Equipos

216746 **TUCLI2001**

No incluye bateria
Ni cargador
Potencia de salida 5v/1A 5v



Taladro Inalambrico Percutor 20 V De 3/8" 45 Nm 0-400/0

605208 **UTDLI20012**

Trae 2 Baterias
Luz De Trabajo Integrada
Indicador Led De Bateria
Trae 1 Broca Para Destornillador
Trae 3 Brocas Para Mamposteria
Cargador Inteligente 110-120 V ~ 50/60 Hz



Taladro Percutor 3/8"

605209 **UTIDLI2002**

Batería de ion de lithion
Mandril 3/8"
Voltaje 20 voltios
Velocidad 0-400 / 0-1500 / min
Máximo de torque 45 nm
Capacidad de metal 10 mm (3/8")
capacidad para madera: 25mm
Concreto capacidad 3/16-3/8"
Torque 18+ 1 + 1

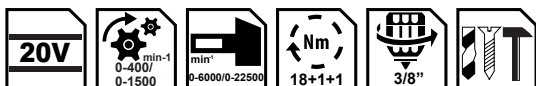

Taladro Inalambrico De 1/2" 20V Funcion De Impacto

605204 **UTIDLI20031**

Amperaje 2.0Ah
Voltaje 20V
Torque máx 45NM
Velocidad 0-450/0-1900/min
Incluye 2 baterías 20V y cargador



Taladro Inalambrico 12V De 3/8" 20Nm 0-600/Min Litio 12V

605239 **UTDLI1211**

Control de torque 15+1
Máximo torque 20NM
Tipo de batería Litio 1.5 Ah
Tiempo de carga 2 hr
Mandril 3/8" sin llave
(funciona con brocas desde 0.8 mm a 10mm)
Capacidad Capacidad de Perforación: 0.8 - 10mm

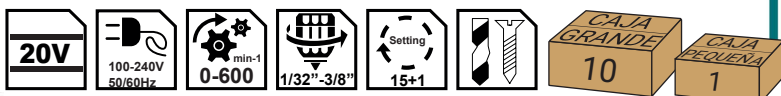

Taladro 12V Batería De Litio 0-600Rpm

605200 **UTDLI12415**

20nm mandril de 1/32" o 3/8" sin llave
 Luz integrada de trabajo
 Control de torque 15+1
 Incluye (1) batería de 1.5 ah
 Cargador 110v-120v~60hz
 Una punta cr-v 65mm



Taladro 12V S12 De Baterías Litio 0-400/0-1500Rpm

605675 **UTDLI12352**

Mandril 3/8" sin llave
 Luz integrada de trabajo
 Control de torque 15+1
 110v-120v~60hz
 Incluye (2) baterías de 1.5 ah
 Cargador, una broca de 65mm y bolso



Taladro De Impacto 12V 0-400/0-1500/Min

605201 **UTIDLI1232**

Impacto 22500/min 20nm
 Mandril de 1/32" o 3/8" sin llave
 Luz integrada de trabajo
 Control de torque 18+1+1
 Batería de 1.5 ah
 Cargador 110v-120v~60hz
 (1) punta cr-v 65mm
 (3) brocas para concreto



Taladro Inalambrico 20V 3/8"

605207

UTDLI20011

Voltaje: 20v

Velocidad sin carga 0-400/0-1500/min

Máximo torque 45nm

Mandril 1/32"~3/8"

Control de torque 15+1

Velocidades 2

20v batería de litio de 1.5ah

Cargador de carga rápida 110-120v~60hz



P20S

1.5Ah



Taladro Inalambrico Percutor 20 V De 3/8"

605673

UTIDLI20012

Trae 2 Baterias 1 Cargador Inteligente

110-120 V ~ 50/60 Hz

Luz De Trabajo Integrada

Indicador Led De Batería

Trae 1 Broca Para Destornillador

Trae 3 Brocas Para Mampostería



P20S

2.0Ah



Taladro Inalambrico 12v 3/8"

605670

UTDLI1222

Voltaje 12v

Velocidad sin carga 0-350 / 0-1350 / min

Par máximo 25nm

Capacidad del portabrocas 0.8-10 mm

Configuraciones de par 15 + 1

12v litio-ion 1.5ah baeries engranaje

Mecánico de 2 velocidades



Impact function



Destornillador / Atornillador Inalambrico 4v

605200 TSDLI0403

Voltaje 4V
Cuadrante 1/4" (6.35mm)
Velocidad sin carga 260/min
Max. torque 5N.m
Luz de trabajo integrada



Flexible Inalámbrica 4 1/2" 20V. 8500 Rpm

605228 UTAGLI1152

Voltaje 20V
Motor sin escobillas
Velocidad sin carga 9000/min
Diámetro de disco 4-1/2"
Eje enroscado 5/8" - 11UNC

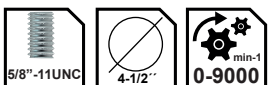

Battery and charger **NOT** included

Sierra Circular Inalambrica De Litio 4.0Ah

216742 TSLI1401

Velocidad sin carga 3600/min
Diametro de hoja 140mm
Capacidad de corte
45 grado 1 - 1/8" [28.5mm]
90 grado 1 - 9/16" [39mm]



Battery and charger **NOT** included

Sierra Circular Inalambrica De Bateria De Litio 20V 4.0 Ah

216743 **TSLI1651**

Voltaje 20V
 Velocidad 4600rpm
 Diámetro de disco 165mm - 6 1/2"
 Capacidad de corte 45° grados:38mm / 90°
 Profundidad de Corte Ajustable
 Bisel de Corte Ajustable
 Incluye Disco de Corte 165mm



P20S
BLMOTOR



Taladro Inalambrico Percutor 20 V De 3/8"

605673 **UTIDLI20012**

Trae 2 Baterias 1 Cargador Inteligente
 110-120 V ~ 50/60 Hz
 Luz De Trabajo Integrada
 Indicador Led De Bateria
 Trae 1 Broca Para Destornillador
 Trae 3 Brocas Para Mamposteria



P20S
2.0Ah



Aspiradora De Limpieza Inalambrica 20V

216744 **TVLI2005E**

Fuerza de vacio => 8 kpa
 Capacidad 20 L
 Diametro de manguera de succion 32 mm
 Longitud de manguera 1.5 m
 Tanque de acero inoxidable
 No incluye cargador ni baterias



Flexible Inalámbrica 4 1/2" 20V. 8500 Rpm

216741 **UTAGLI11522**

Voltaje 20V
 Motor sin escobillas
 Velocidad sin carga 9000/min
 Diámetro de disco 4-1/2"
 Eje enroscado 5/8" - 11UNC
 Con +2 pilas a Ah +cargador



Guadaña Inalámbrica 40V De Doble Batería De Litio 20V

605219 **TSTLI20018**

Dia línea 2.0mm
 Dia corte 330mm
 Motor sin escobillas
 No incluye batería ni cargador
 Velocidad de 0-5500/min 0-7500/min
 Voltaje: 40v (requiere usar dos baterías 20v)



Herramienta Multifunción Oscilante 20V

605672 **TMLI2001**

Velocidad Variable: 5000-20000 rpm
 Con 1 raspador flexible
 Con 1 hoja de sierra de corte
 Con 1 hoja de sierra de segmento
 Con 1 llave hexagonal
 Con 1 base de lijado
 Con 3 hojas de papel de lija
 No incluye Batería y cargador



Battery and charger NOT included



Tijeras De Podar Eléctricas Inalámbrica De Batería Litio 20V

605671 TSSLI2001

Voltaje 20V
Motor Sin Escobillas
Diámetro De Corte 20Mm / 30Mm
No Incluye Batería Ni Cargador



Battery and charger
NOT included



Linterna De Iones De Litio 12V

605676 TWLI1223

Voltaje 12V
Disipación de potencia LED 1W
Brillo 100 lúmenes
Cargador No incluido
Batería No incluido
Compatible con 12V 1.5Ah



Lithium-Ion
S12



Lampara De Trabajo Inalámbrica Litio 20V

216745 TFLI2002

Led 20W
No Incluye Cargador Ni Baterías
1500 Lumen En Alta Y Baja De 750 Lumen



Taladro 280W 3/8"

216747
UTD502106

Cable 4M
 20+1 Ajustes De Par
 Mandril Sin Llave De 10 Mm
 Taladro Eléctrico 280W
 Voltaje 110V-120V ~ 60Hz
 Potencia De Entrada 280W
 Velocidad Sin Carga 0-750Rpm
 Capacidad De Perforación Máxima 3/8""



Flexible Lijadora De 4-1/2"

602545
UTG10711556

Esmeril Angular De 4-1/2""
 Voltaje 110V-120V~60Hz 750W. 5/8"
 Velocidad Sin Carga 12000 /Min
 Diámetro De Disco 4-1/2"
 Eje Enroscado 5/8 - 11Unc
 Mango Auxilia



Pulidora De Felpa 1400W De 7"

216748
UTP1141806

Potencia 1400W
 Vel.900-3800Rpm
 Caja De Engranajes En Alum
 Diámetro de disco 180 mm (7")
 Incluye 1 Felpa Y 1 Plato
 Voltaje 110V-120V~60Hz



Rotomartillo Sds Plus 800W

605251 UTH308268-2

Voltaje 110V-120V~60Hz
 Energía De Impacto 2.5J
 Velocidad Sin Carga 0-1100/Min
 Tasa De Impacto 0-4000Bpm
 Mandril Sds Plus
 Perforación En Concreto 26Mm
 Perforación En Acero 13Mm
 Perforación En Madera 30Mm
 Incluye (3) Brocas, (2) Cinceles Y Maletín



Pistola De Silicon Con 8 Barras De Silicona

605260 UTT301116

Diámetro De Barra 11.2 mm
 Voltaje: 110-120 V ~ 50 / 60Hz.
 Potencia De Entrada 30 W (220 W)
 Capacidad De Pegado 20-30G / Min
 Tiempo De Pre calentamiento 3-5 Minutos
 Sistema De Alimentación Mecánica Para
 Medición Sensible Y Aplicación Rápida



Pistola De Calor 2000W

216753 UTB20036

Potencia 2000W
 Voltaje 110-120V~50/60Hz
 Temperatura 480°C/560°C
 Incluye: 3 boquillas y un raspador de metal



Taladro De Banco 350W

216754 **UTDP133501**

Voltaje 110-120v ~ 60hz.
 Capacidad máxima de perforación 1/2»
 Velocidad sin peso 760-3070 rpm
 Ajustes de velocidad 5 niveles
 Husillo 50 mm. Diámetro de la columna 46 mm
 Mesa de trabajo ajustable
 Tamaño de la mesa 160 x 160 mm
 Tamaño base 291 x 183 mm
 Peso neto 19 kgs
 Altura de la máquina 590 mm



Flexible Lijadora De 4-1/2"

216755 **TS9204051**

Voltaje 220-240v ~ 50 / 60hz
 Potencia de entrada 3000w
 Sin velocidad de carga 2280 / min
 Diámetro de la hoja 405 mm * 25,4 mm * 3 mm
 Capacidad de corte tubo de acero 135 * 6 mm
 Angulo de hierro 100 * 10 mm
 Canal de acero 126 * 53 mm



Taladro De 1/2" 680W

605240 **UTG1061356**

Mandril 13mm
 RPM 3000 rpm
 Voltaje 110V-120V~60Hz
 Velocidad sin carga 0-3000/min
 Capacidad 2 velocidades en ambos sentidos



Esmeriladora Angular 5" 1500W

605668 **UTG11512526**

Voltaje 110-120v ~ 50 / 60hz
 Potencia de entrada 1500w
 Velocidad sin carga 11000rpm
 Diámetro del disco 5"
 Rosca de husillo 5/8"-11unc
 Con mango auxiliar de 1pcs
 Con cepillos de carbono de 1 conjunto
 Con llave de 1pcs
 Embalado por caja de colores



Esmeriladora Angular 7" 2400W

605665 **UTG1251806**

Potencia 2350W
 Diámetro De Disco 7", 9"
 Eje Enroscado 5/8 - 11Unc
 Voltaje 110-120V~50/60Hzda
 Velocidad Sin Carga 8500, 6300 /Min



Sierra circular 1400W

216751 **UTS1141856**

Voltaje 110-120v~50/60hz
 Potencia 1400w
 Velocidad sin carga 4800/min
 Capacidad de corte 90°=65mm/45°=44mm
 Diámetro de disco 185mm



Mini MotoTool 130W

605666 **UTG501032**

Potencia 130W
 Velocidad variable
 Frecuencia 50/60Hz
 100 piezas en accesorios
 Voltaje 110-120V~50/60Hz
 Tamaño Tamaño de cuello 3.2mm
 Velocidad sin carga 10000-32000/min



Lámpara De Trabajo

216777 **TWLI35261**

Brillo 300 lúmenes
 Peso 540g



Portaelectrodo Para Soldar 300 AMP



605276 **TWAH3006**

Copper

Corriente nominal 300 ah
 Adecuado para la maquina de soldar mma



Soporte De Soldadura Escuadra Magnetica De 5"

216756 **TAMWH75052**

Angulo de sostener 45°, 90°, 135°
 Fuerza de tracción 75 Libras
 Material Metal
 Materiales Imán y Acero
 Peso (Kg) 1.278 Kg
 Tamaño 5"

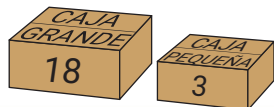

Soporte De Soldadura Escuadra Magnetica De 4"

470853 **TAMWH50042**

Angulo de sostener 45°, 90°, 135°
 Fuerza de tracción 50 Libras
 Material Metal
 Materiales Imán y Acero
 Peso 0.667 Kg
 Tamaño 4"

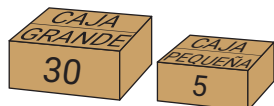

Juego De Dados Socket De Impacto De 1/2» Dr. 10 Pz



216758 **THISTD12101**

Largo 38 mm CrMo
 Tratamiento Térmico
 Tamaños 10.12.13.14.15.17.19.21.22.24 mm

10Pcs/Set 1/2" CR-MO

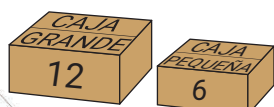

Juego De Dados Socket Largos De Impacto De 1/2" Dr. 10 Pz

216759 **THKISD1210L**

Material crmo
 Longitud 78mm
 Colgador plástico
 Tratamiento térmico
 10 pzas 1/2" set de dados de impacto
 Tamaños 10.12.13.14.15.17.19.21.22.24mm

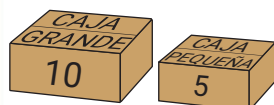

10Pcs/Set 1/2" CR-MO

Juego de brocas de 16 piezas

216761 **UTACSD3165**

Incluye :

(6) para metal: 5/64", 7/64", 5/32", 3/16", 7/32", 5/16"

(5) para concreto: 5/32", 3/16", 7/32", 5/16", 3/8"

(5) para madera: 5/32", 3/16", 15/64", 5/16", 25/64"

(6) para metal: 5/64", 7/64", 5/32", 3/16", 7/32", 5/16"

(5) para concreto: 5/32", 3/16", 7/32", 5/16", 3/8"

(5) para madera: 5/32", 3/16", 15/64", 5/16", 25/64"



Juego De Brocas Para Concreto. 5 Pz

216762 **UTACSD5051**

Tamaños 5/32 "X3-3 / 8", 3/16 "X4",
 1/4 "X4-3 / 4", 5/16 "X4-3 / 4", 3/8 "X4-3 / 4 "

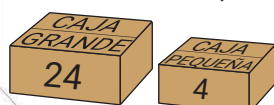

Disco De Corte Para Metal Plano



216778 TAC2211802

Diámetro 7"
Hueco 22.2mm
Espesor 1.6mm



Disco Para Corte Para Metal abrasivo



605425 TAC2212302

Diámetro 230mm
Hueco 22.2mm
Espesor 1,6mm

Disco De Corte Para Metal Plano



605426 TAC2213551

Diámetro 335mm
Hueco 25.4mm
Espesor 3mm



Disco De Diamante 115 X 22Mm Segmentado

605297 TAC2111153

Usos Concreto
Para corte en seco
Medida 115 X 22mm
Ancho (cm) 0.75 cm



Disco De Diamante 115Mm (4-1/2"") X 22Mm

216763 TAC21111532

Ancho De Navaja 7Mm
Para Corte En Seco

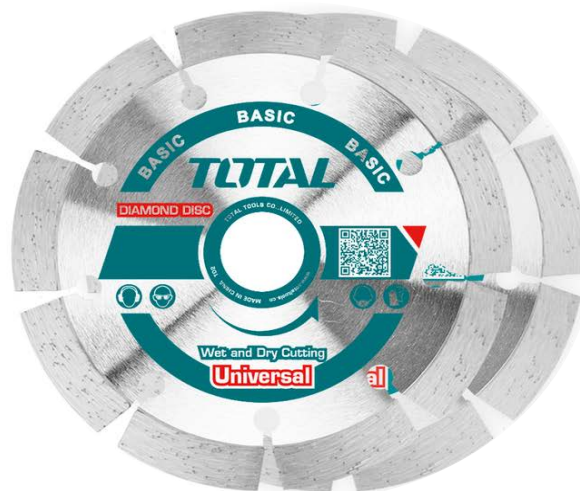

Disco De Diamante 180 (7") X 22Mm

605298 **TAC2111803**

Material crmo
 Longitud 78mm
 Colgador plástico
 Tratamiento térmico
 10 pzas 1/2" set de dados de impacto
 Tamaños 10.12.13.14.15.17.19.21.22.24mm



Disco De Diamante 230 (9") X 22Mm

605299 **TAC2112303**

Para Corte En Seco
 Para piezas de metal, piedra, acero inoxidable



Disco De Diamante Liso 115 (4-1/2") X 22Mm

605300 **TAC2121153**

13000 RPM
 Para usar con agua
 Ancho de sierra 5mm



Disco De Desbaste Para Concreto 4 1/2" 115 Mm

216764 TAC2421151

Material metal
18 hojas de desbaste
Medida \varnothing (mm) 115 x 22.2 (7/8")



Disco Corte Madera 185Mm(7-1/4") 60T

605434 TAC231413

Dientes 60T
Mandril 20mm
Max RPM 8200
Diámetro 185mm, 7 1/4"
Anillo reductor(mm) 16



Disco De Alambre 3" Con Rosca 5/8" 11 Unc

216765 UTAC31031

Diámetro Alambre 0.3 Mm



Juego 357 Pcs Acces P/Mototool

216766 TACSD13571

Incluye discos d/corte,
lijas, cepillos, brocas,
desvaste y gravado,
piedras varias, ruedas d/pulido.

357PCS



10Pcs /Pack Punta Stella Ph2 50 Mm Para Tornillos

216767 TAC16PH223

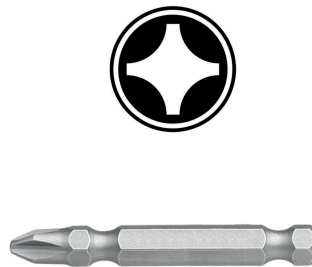

Juego 10Pcs Puntas Phillips Ph2 Y Paleta

216768 TAC16HL133



Juego De Puntas Para Destornillado Ph2 (10 Piezas, 50Mm)

216769

TACIM16PH223

CAJA GRANDE
100



Impact



50mm

Juego De Puntas Magnéticas De Impacto

216771

TACIM16PH263

Tamaño PH2
Largo 150 mm
Vástago hexagonal 1/4 "
(10Pzas) Puntas Magnéticas Ph2 - 150Mm

CAJA GRANDE
50

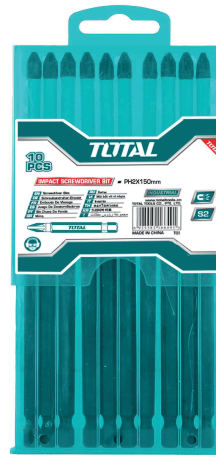

10Pcs/set



Impact 150mm

Juego Puntas Destornilladores Tipo Broca

216772

TACSD18306

Tamaño 25mm
30 Pzas Ph1-2-2-2-3, SI3-4-5-6-7
Pz1-2-2-2-3, T10-15-20-25-27-30-40, H3-4-5-6

CAJA GRANDE
40

CAJA PEQUEÑA
4

30Pcs/set



IMPACT

Juego De 9 Pza Magneticas Con Adaptador

216773 **TACSD3091**

Ph1,Ph2,Ph3,SI4.0,SI5.5,SI6.5,Pz1,Pz2



Juego De Puntas De Destornilladores Tipo Broca

216774 **TACSD10306**

1 adaptador magnético
PZ0-1-2-2-3, PH0-1-2-2-3-4, SL3-4-5-6,
T10-15-20-25-27-30-40, H3-4-5-6, S1-2-3

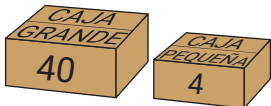

Set De Adaptadores Para Sockets 1/4", 3/8", 1/2"

216775 **TAC273651**

Material 50Bv30
Shank 1/4" Hexagonal
3Pcs/Set 1/4", 3/8", 1/2"
Longitud li: 73Mm (1/2")
Longitud l: 65Mm (1/4", 3/8")



Llave Para Mandrill Para 13 Mm Largo 10 Mm

216776 **TAC470131**

Incluye discos d/corte,
Lijas, cepillos, brocas,
desvaste y gravado,
piedras varias, ruedas d/pulido.

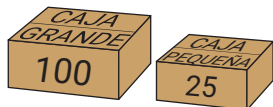

Set 10 Hojas Cuchillo Cartonero Retractivil Total 61mm

605615 **THT519611**

Para Exacto De Metal 61X19Mm

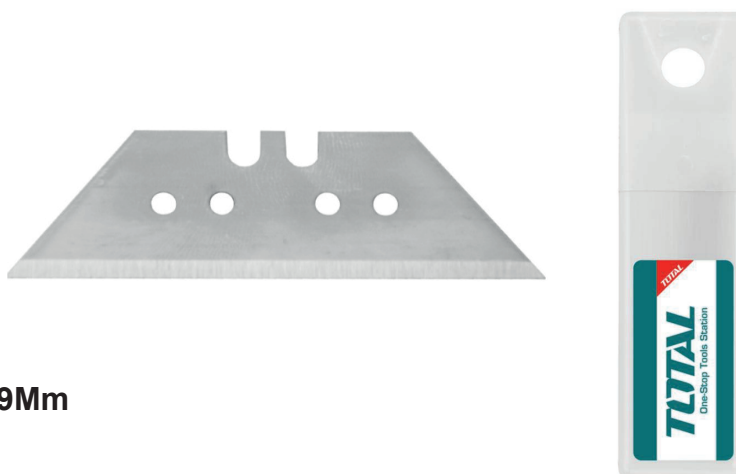

Rueda De Corte De Repuesto Para Cortadora

605655 **THT578004B**

Cortadora de ceramica

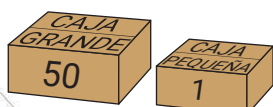

JJuego De 6 Barras De Silicon

605667 **TACGT2061**

Longitud 20cm
 Diámetro 11,2 mm
 Material resina de petróleo



Juego De Brocas Para Concreto De 5 Piezas

605663 **UTACSD5055**

Tamaños:
 5/32" X 3-3/8": 3/16" X 4"
 1/4" X 4-3/4": 5/16" X 4-3/4": 3/8" X 4-3/4"



Kit En Lata De 50 Discos Corte De Metal Y Acero Inoxidable

605295 **TAC22111550**

Disco Plano Tipo 41
 Cantidad x Empaque 50
 Medidas 115Mm (4-1/2"") X 1.2Mm (3/64") X 22.2Mm (7/8"")



Hoja De Sierra De 235 mm (9-1 / 4 ") 60T

605677 **TAC231623**

235 mm (9-1 / 4 ") 60T
Eje: 30 mm 16 mm y anillo de 25,4

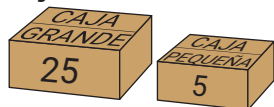

Disco Corte Aluminio Tct 254 Mm (10") 100T

605436 **TAC2337210**

Para Cortadora Ts42182551 Ts42182553
Arbor 30Mm 16Mmm y anillo de 24.5 Mm



Disco Corte Aluminio 305 Mm (12") 120T

605437 **TAC2339212**

Corte de aluminio
Sierra ingletadora
Max. velocidad 5000 / min
Rango de aplicación 120T
Diámetro de la hoja 305 mm (12 "),
Eje 30 mm, anillo de reducción 25,4 16 mm



Pistola Spray Boquilla 1.5Mm

216757 **TAT10402**

Salida de aire 3.5-
Adecuado para capa base
Capacidad de pintura 400cc
Presion de operación 3-4bar
Boquillas opcionales de 1.5-2.0 mm
Ajuste de ancho de salida 180-250mm
Con conectores tipo europa, usa, nitto e italia

CAJA
GRANDE
10



Pistola Spray Boquilla 1.3Mm

216767 **TAC16PH223**

Capacidad De Pintura 600Cc
Presion De Operación 2.0Bar
Boquillas Opcionales De 1.5-2.0 Mm
Ajuste De Ancho De Salida 180-260Mm
Adecuado Para Capa De Acabado Y Pintar Autos
Con Conectores Tipo Europa, Usa, Nitto E Italia

CAJA
GRANDE
100

CAJA
PEQUEÑA
25



Pistola de aire 16mm

605664 **TAT3031.1**

Boquilla 16 mm
Entrada aire 1/4"
Presión 2-6,3 bar
Caudal 100-200 L/min

CAJA
GRANDE
50



Pistola De Clavo Neumática Con Gatillo De Seguridad

605274 **TAT83301**

Con capacidad de clavos 100pcs
 Usa clavos de tamaño 10-30mm
 Y calibre ga18,1.25x1.00mm
 Presión de trabajo 0.4-0.7mpa(60-100psi)
 Con conector tipo europeo/usa/italiano



Pistola De Clavos Neumática 15-50Mm

216760 **TAT83501**

Conector De Tipo Usa
 Con Uñas Brad De 1000Pcs
 Capacidad De Carga 100Pcs
 Con Conector De Tipo Europa
 Tamaño Brad 15-50Mm Ga18, 1.25X1.00Mm
 Conector Tipo Nitto Y Conector De Tipo Italia
 Presión De Operación 0.4-0.7Mpa(60-100Psi)

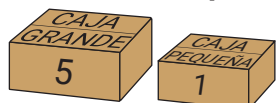

Juego de destornilladores 4 piezas

MANUAL

605335 **THT250604**

1Pcs SL5.5X100mm
 1Pcs SL6.5X150mm
 1Pcs PH1X100mm
 1Pcs PH2X150mm
 Material CRV Hoja redonda



Ventosa Doble Succión

605679 **TSP02501**

Mango De Abs
Soporta 50Kg De Peso
Diámetro De Succión 115M



Tijera De Aviacion De 250 Mm (10") Recta

605680 **THTJ532106**

Espesor Máx
Acero Inoxidable ≤ 0.7 Mm
De Corte Acero Al Carbono ≤ 1.2 Mm



Mini Martillo Forjado Acero #45 Mango Fibra Vidrio



216781 **THTM7386D**



Martillo Tipo Ingles Acero #45 Mango Fibra Vidrio



Martillo Tipo Ingles Acero #45 Mango Fibra Vidrio



Martillo De Bola Acero 45# Mango Fibra Vidrio 16Onz/450G



Martillo De Bola Acero 45# Mango Fibra Vidrio 320nz/900G



605554 **THT74326**



Martillo Tipo Ingles Acero #45 Mango Fibra Vidrio



605555 **THTCH0166**



Mazo De Goma 45% Goma Natural 16Onz/450G



605306 **THT731636**



Alicate Punta Larga 6"



605556

THT220606S



Kit 3 Alicates De Combinación Aislados 1,000 Voltios



605557

THT2K0302



Cr-V

Alicate De Combinacion Aislado Probados En 10,000Voltios



605317

THTIP181



Alicate De Presión Para Soldador



605558 **THT1921003**



Alicate De Presion Tipo C Abrazadera Con Anillo De Amarre



605323 **THT111113**

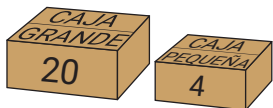

Separador De Alambre De 0.5 A 6 Mm



605559 **THT15606**



Alicate Pela Cables 8.5"



605560

THT15851



Alicate Para Crimpar Conectores Eléctricos 0.5-6Mm²



CRIMPING RANGE:
0.5-6mm²



Non-insulated tabs & receptacles

650562

THCPC0506



Juego De Alicates Para Anillos De Retencion De 7"/180 Mm

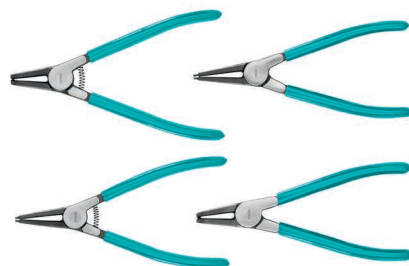
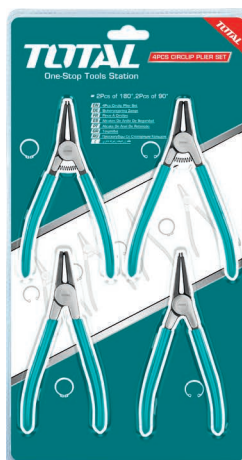

605563

THTJ214041



More Stronger 5

Llave Tubo De 48 "



605564 **THT171486**



Llave Tubo De Aluminio Total 18 " Aluminum Handle



605656 **THTAL17186**

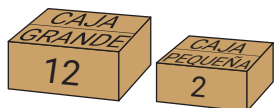

Cizalla Mini 8



605566 **THT11386**

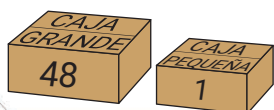

Cizalla 18"



605567 **THT113186**

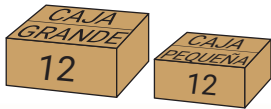

Cizalla 42"



605568 **THT113426**

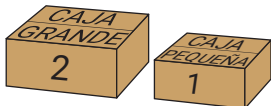

Cortador De Tubo De Cobre Y Alumnio Corta Hasta 32 Mm



605569 **THT53321**

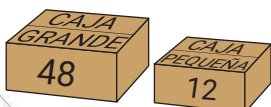

Destornillador Plano 40 Cr Mango Redondo



605570 THTDC2156



Destornillador Phillips 40 Cr, Ph1, Mango Redondo 5 Mm



605462 THTDC2246



Destornillador Phillips 40 Cr, Ph2, Mango Redondo 6 Mm



605571 THTDC2256



Juego De 4 Destornilladores Mango Ergonomico



605572

THTDC250401

CAJA GRANDE
30

CAJA PEQUENA
3

Juego De Destornilladores De 10 Pcs

10Pcs/set



605333

THTDC251001

CAJA GRANDE
40

Juego De Destornilladores De 6 Piezas



605465

THGSS35061

CAJA GRANDE
20

CAJA PEQUENA
5

Destornillador Corto De Paleta SI 6.5Mm

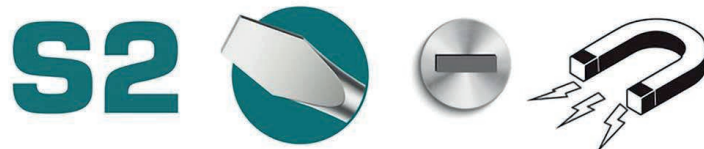

605573 **THT266038**



Destornillador Corto De Estrella Ph2 6Mm



PH2x38

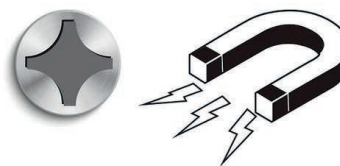

605674 **THT26PH2038**



Desatornillador Phillips Ph0 X 3"



PH0x75

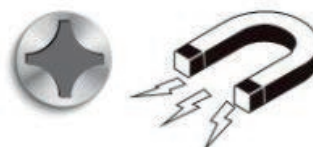

605575 **THT26PH0075**



Desatornillador Phillips Ph1 75mm



PH1x75



605576

THT26PH1075



Destornillador De Estrella Ph2 Diam 6.0 Mm



PH2x125



605577

THT26PH2125

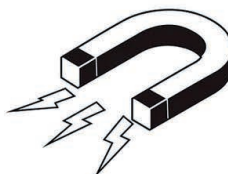

Destornillador De Estrella Ph3 Diam 8.0 Mm



PH3x200



605578

THT26PH3200



Juego De 8 Pcs De Destornilladores Variados

605579 **THT250608**

CAJA GRANDE 20
CAJA PEQUEÑA 5

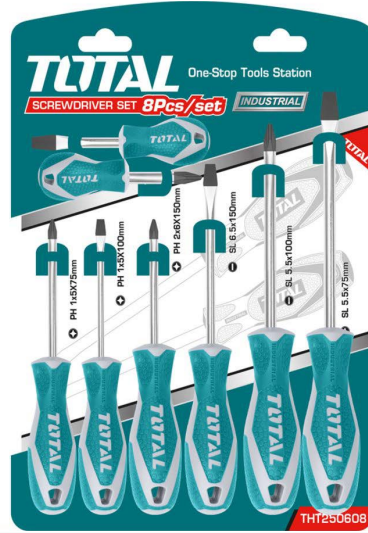

Juego De Destornilladores 10 Unidades

605337 **THT250610**

CAJA GRANDE 20
CAJA PEQUEÑA 5



Juego De Destornilladores Variado

605580 **THGSS2206**

CAJA GRANDE 30
CAJA PEQUEÑA 6



Juego De Picos Y Ganchos De 4 Piezas



605581

TPHSK0401

CAJA
GRANDE
48CAJA
PEQUENA
8

Juego De Destornilladores De Precision Variado

605583

TACSD30326

De 32 pzas
 1 mango de plastico
 1 soporte para brocas de 4x60mm 30 pzas
 Brocas de 4x28mm sl1.5, sl2, sl2.5, sl3,
 sl3.5, sl4, ph000, ph00, ph0, ph1, t4, t5,
 T6, t7, t8, t9, t10, t15, t20, h0.9, h1. 3, h1.5



Juego De Brocas Destornilladores Con Mango Tipo T

605341

TACSD30476

De 47 piezas
 Incluye 35 brocas
 Destornilladores de 6.35 x 25
 Mm sl3 sl4 sl5 sl6 sl7 ph0 ph1x3 ph2x5
 Ph3x3 pz0 pz1 pz2x2 pz3x2 t10 t15 t20
 T25 t27 t30 t40 h2 h3 h4 h5 h6. 9 brocas

CAJA
GRANDE
24CAJA
PEQUENA
4

Juego De 55 Pzas Brocas Con Destornillador Intercambiable

605584 TACSD30556

Incluye 21 Pzas 6.35X25Mm: SI4, SI5, SI6, Ph1, Ph2, Ph2, Ph2, Ph3, Pz1, Pz2, Pz3, T10, T15, T20, T25, T30, T40, H3, H4, H5, H6.
20 Pzas 4X28Mm De Precision: SI1.5, SI2, SI2.5, SI3, Ph000, Ph00, Ph0, Ph1, T6, T7, T8, T9 T10



Kit De Herramientas 7pzs



605585 THKTHP90076



Juego De Herramientas De 9 Pzas



605342 THKTHP90096



Juego de Herramientas Manuales de 11 piezas



605586 **THKTV02H111**



Destornilladores de tuerca aislada de 7 piezas (6-12 mm * 125 mm)



605587 **THKISD0701**

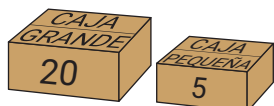

Juego De Destornilladores Aislados De Precisión (6 Piezas)

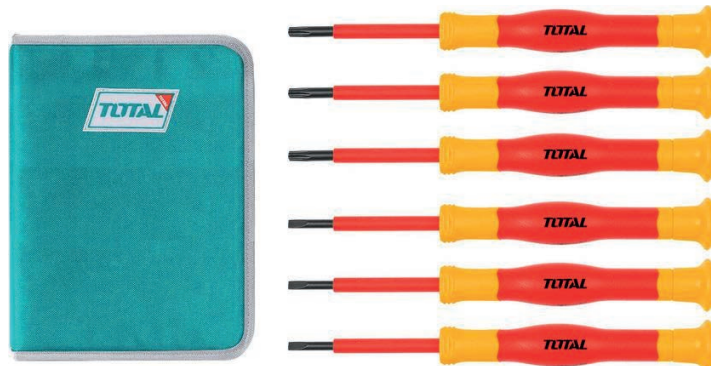

605589 **THKIPSD0601**



Llave Ajustable Aislada 10" 1000V



605590

THIADW101



Ratchet Con Socket Total Tools Con 24pcs



605347

THT141253



Maletin Mixto De 12 Pcs De Puntas Para Router De 1/2"



605662

TACSR0102121



Juego De Dados Socket De 3/4" Dr

605592 THT341151

De 15 piezas Cr-v (50 bv 0)
Cromado de tratamiento térmico
Incluye 10 dados socket de 3/4" 30-32-
34-36-38-41-46-50-55-60 mm
1 barra ratchet de 3/4" 24t
1 barra extensión en t deslizante de 3/4" 520mm

CAJA
GRANDE
1

3/4"
15PCS/SET
24T
Cr-V



Caja De Herramientas De 97 Piezas

605593 THPTCS70971

Tamaño 520*218*243Mm
Bandeja 506*215*63Mm
Gavetas 449*196*54Mm

CAJA
GRANDE
1

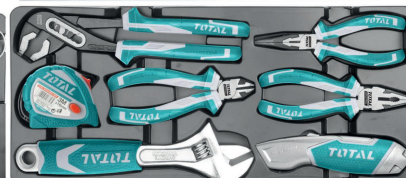

Bolsa De Herramientas Tamaño 13"

605594 THT261325

Carga Máxima 12Kg
Con 6 Bolsillos Al Aire Libre

CAJA
GRANDE
40

CAJA
PEQUEÑA
2

13"



Bolsa Para Herramientas De Cinturón L32 * W28Cm



605595 **THT16P1011**

Material 600D Polyester
Para 10 Herramientas Y 2 Martillos



Morral Bolso De Espalda Para Herramientas

219786 **THBP0201**

De polyester oxford 600d
1 bolsa con asa interior
Tamaño 34 cm x 17 cm x 45 cm
Marco rigido para facil apertura
Facil acceso a bolsillos internos y externos

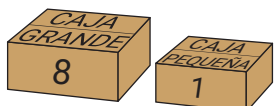

Abrazadera en forma De G 6"



605596 **THT13136**



Abrazadera En Forma G De 8"



605597

THT13186



Prensa Tipo F 120x400 Mm



605598

THT1321202



Prensa Sargento De Barra De 6"

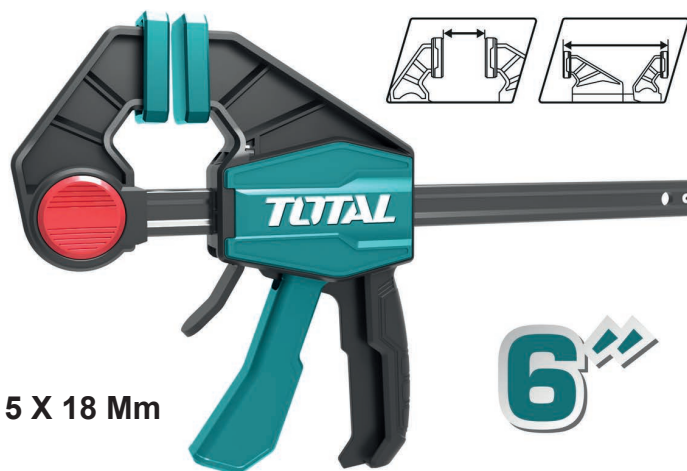

605599

THT1340601

Medidas 63 X 150 Mm

Max Fuerza De La Prensa 60 Kg

Espesor Y Ancho De La Regla De Hierro 5 X 18 Mm



Prensa Sargento De Barra De 12"

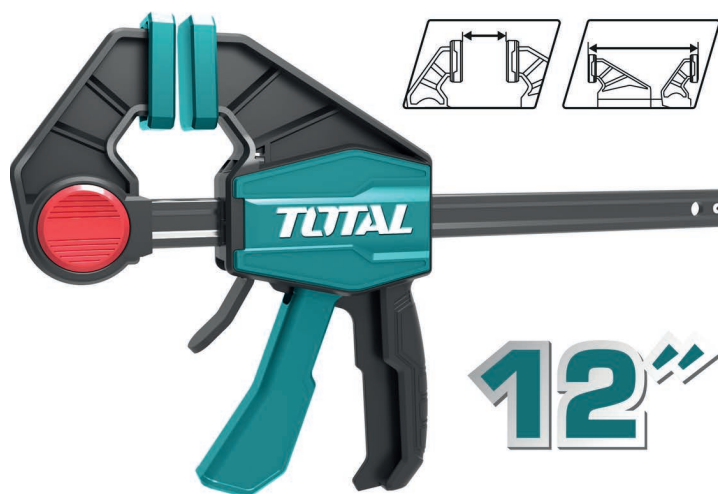

605600

THT1340602



12"

Prensa Sargento De Barra De 18"

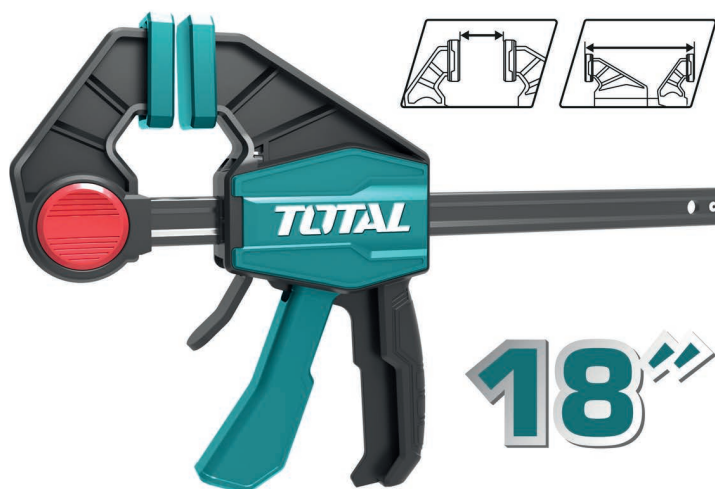

605601

THT1340603



18"

Pinza De Resorte Para Sujecion De 4"

605602

THT13342

Longitud De 110 Mm
Max Abertura 50 Mm
Fuerza De Agarre 12 Kg



4"

Extractor De 3 Mandibulas 3" 3000Kg



605659

THTGP336



Prensa De Banco Base Giratoria

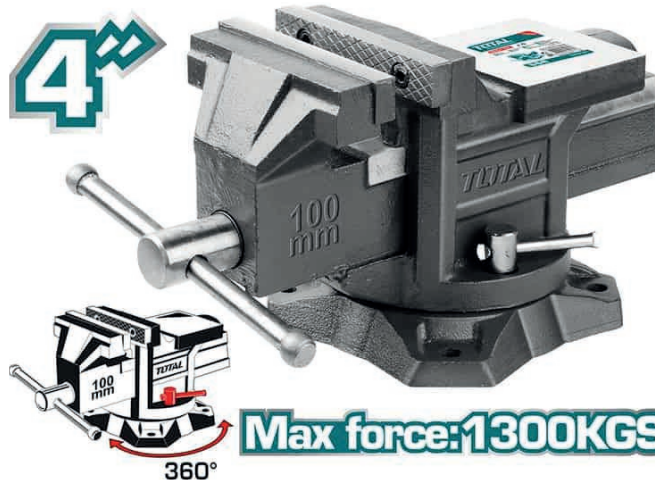

605603

THT6146



360°

Max force: 1300KGS

Cinzel Industrial 305 mm

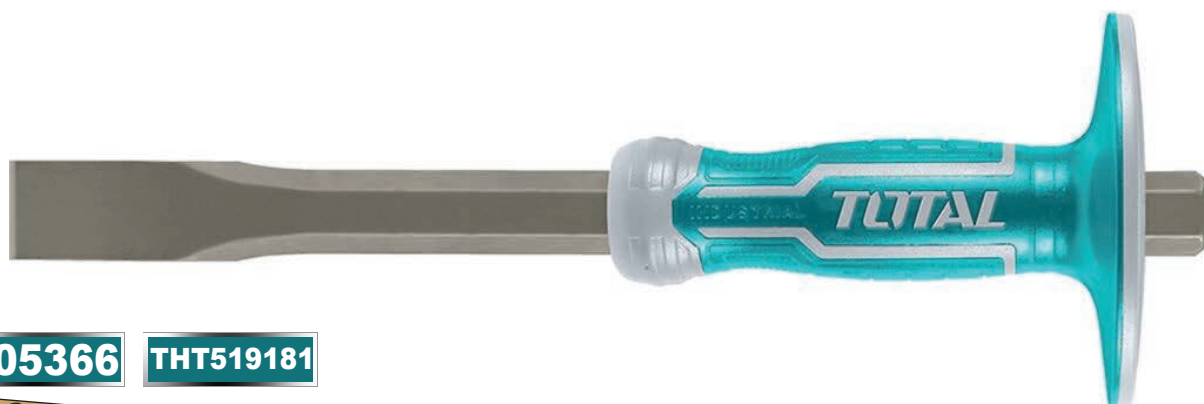

605366

THT519181



Cinzel Frío - 305 Mm / 25 Mm



605490

THT4411219



Cinzel De Hormigón De 4 Mm Cabeza



605491

THT4421219



305mm

Remachadora Manual De 10.5"



605604

THT32108S



Remachadora Manual De 10"



605605

THT32101



Remachadora Giratoria 360 Grados 10.5"



605606

THT32106



Remachadora 13"



605607

THT32131



Grapadora Industrial. Grapas 6-14Mm, Peso 800G



Marco De Sierra Para Metales 12

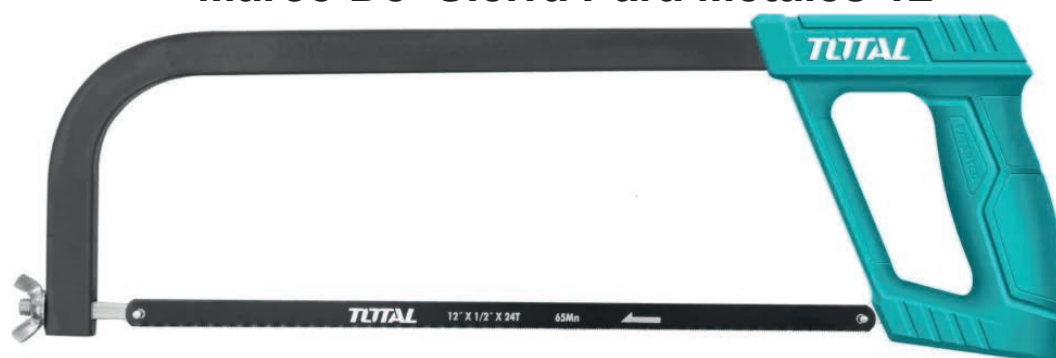

Marco De Segueta Ajustable 300mm (12")

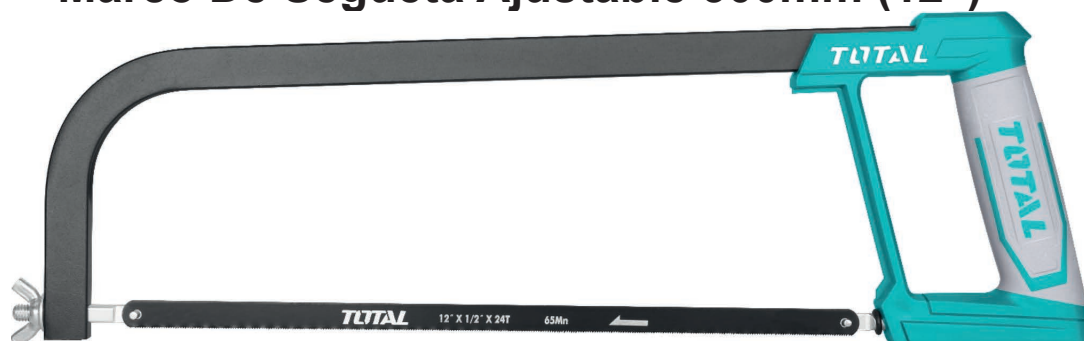

Segueta 12"/300 Mm Con Mango Suave



605609 **THT541026**



Segueta Industrial Para Metal De 300 Mm / 12"

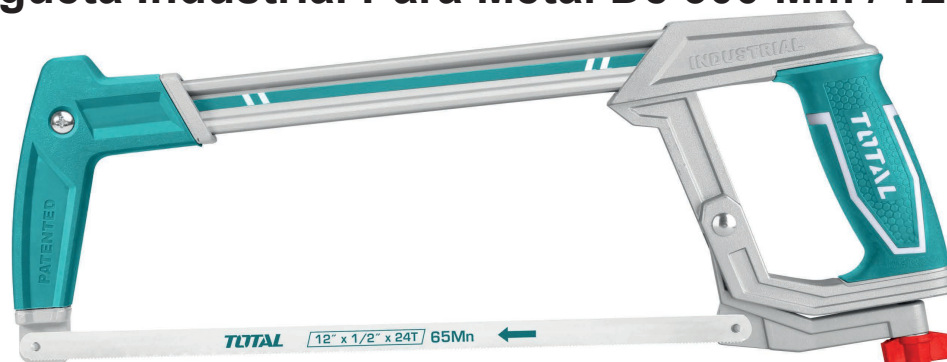

605610 **THT54106**



Serrucho De Mano De 18 " / 450 Mm

18" (450mm)



605611 **THT55450**



Serrucho De Mano De 18 "/ 65 Mm



605361 **THT55186**



Serrucho Trasero 12"/300 Mm

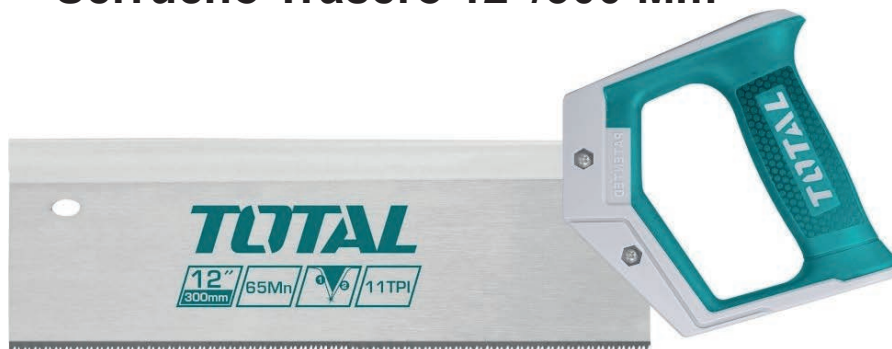

605612 **THT59126B**

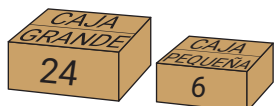

Cutter De 173 Mm Con Cuchillas De 18 Mm X 100 Mm



605494 **THT511826**

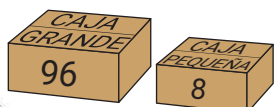

Cutter 3/4 X 4" 169mm



3PCS
SK5 blades

605613

THT511836

CAJA GRANDE
96

CAJA PEQUEÑA
12

Cutter Con Cuchillas De 61 Mm X 19 Mm



605614

THT5126128

CAJA GRANDE
72

CAJA PEQUEÑA
12

Cutter Plegable Con Mango De Aluminio Con Cuchillas De 61 X 19 Mm



Stainless steel



x6
SK5 blades

605616

THT5136288

CAJA GRANDE
72

CAJA PEQUEÑA
8

Herramienta Multifuncional En Acero Inoxidable



605496

TFMFT01151

CAJA GRANDE
36

CAJA PEQUEÑA
6



Ventosa, Mango De Abs Soporta 25Kg De Peso



605617

TSP01251

CAJA GRANDE
36

CAJA PEQUEÑA
3

Tijeras De Aviador 250Mm(10")



Stainless steel
0.7mm



Carbon steel
1.2mm



605619

THT521106

CAJA GRANDE
40

CAJA PEQUEÑA
5

Tijeras De Aviacion (Recta) 10 "/ 250Mm Acero



605620 **THT522106**

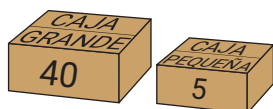

Tijera De Aviador Derecha 250Mm(10")

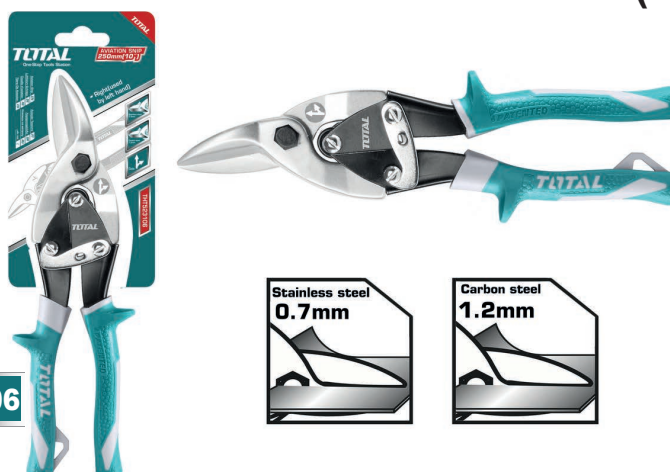

605618 **THT523106**

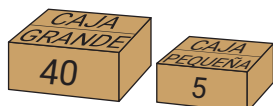

Tijera De Aviacion Larga Recta De 300 Mm 12"



605621 **THT525106**

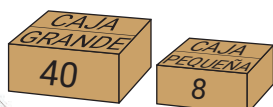

Tijera De Aviacion De 250 Mm (10") Izquierda



605497 **THTJ531106**

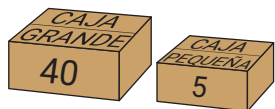

Tijera De Aviacion De 250 Mm (10") Derecha



605369 **THTJ533106**

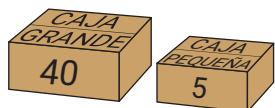

Juego De Tijeras De Aviacion De 250 Mm 10"



605622 **THT520106K**

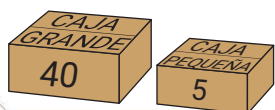

Tijera De Hojalatería De 12" Acero Forjado



Tijera De Hojalateria De 10"



Tijera De Hojalateria De 12"



Juego De 6 Limas Delgadas 140X3 Mm Plana



605623

THT91462



Pistola De Silicon 9"



Suitable sealant size:



605498

THT20209



Pistola De Calafateo De Aluminio De 9"



605372

THT20109



Pistola De Grasa De Servicio Pesado



Dual Piston



600cc Rubber Handle

605624

THT111062



Brocha De 2" 50.8Mm

50mm
(2")



605625

THT845026



Brocha De 3" 76.2Mm

75mm
(3")



605626

THT845036



Juego De Llaves Anulares Acodadas De 12 Pzas 6-32 mm



605627

THT1024121



Llave Combinada Cromada Mate 20mm Largo 242mm



605565

TCSPA201



Llave Ajustable 10"



605628

THT1010103



Llave Ajustable De 12"

**605629****THT1010123**

Llave Ajustable de 15"

**605630****THT1010153**

Llave Ajustable De 18"

**605631****THT1010183**

Juego De Llaves Allen 8 Pzs Portátil



605632

THT1061826



Juego De Llaves Torx Con Mango T De 8 Pzs

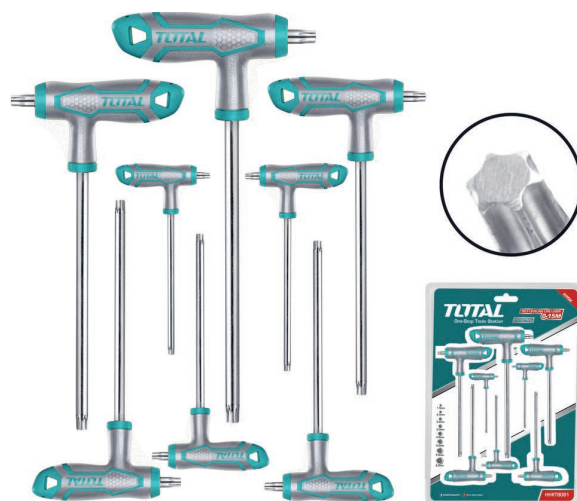

605633

THHW8083

Material:

Cr-V , Tratamiento Térmico Y Placa De Cromo

Medidas: T10X75, T15X75, T20X100,

T25X100, T30X150, T40X150, T45X200, T50X200



Extension Barra En T Deslizante De 1/2"

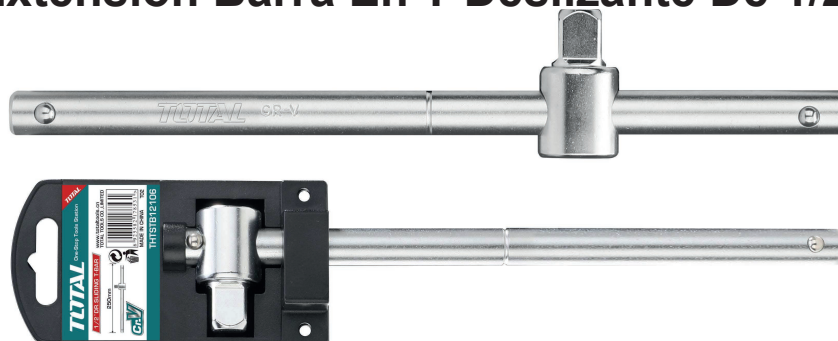

605634

THTSTB12106



Extension Barra Articulada Flexible De 1/2"

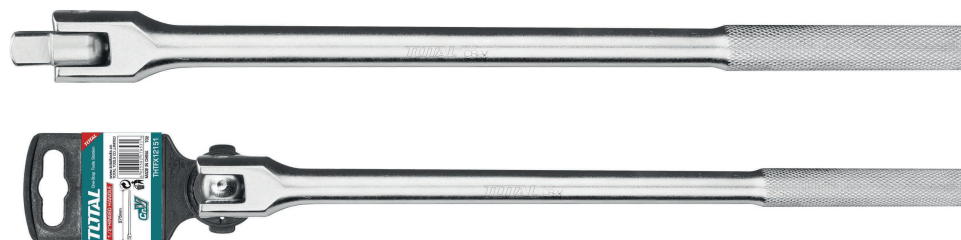

605635

THTFX12151



Cortador De Azulejos 600 Mm



605636

THT576004



Gato Hidráulico De Botella De 20 Toneladas

605637

THT109202

20 toneladas
 Con válvula de seguridad
 Min. Altura: 242 mm
 Max. Altura: 452 mm



Gato Hidráulico Largo Estilo Patín

605638 **THT10834**

De bajo perfil
Con bomba doble para
levantamiento rápido
Capacidad 3 toneladas
Altura mínima 85mm,
Altura máxima 515mm



80mm
Low Profile

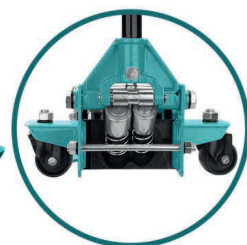

Fast lifting
Dual pump

Diferencial Manual 2 Toneladas Cadena 3m



605639 **TCBK0202**



Diferencial Manual 3 Toneladas Cadena 3m



605640 **TCBK0203**

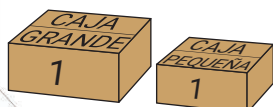

Cinta Métrica (Métrico / Pulgada) Acero De 2Mts



Metric
and Inch

605641

TMT126321



Cinta Métrica Y Pulgada 3 Mts X 16 mm



605642

TMT126031



Cinta Métrica 3 Funciones De 5Mts Botón De Parada 19mm



605643

TMT126051



Cinta Métrica Y Pulgada 8 Mts X 25 mm



605644 **TMT126081**

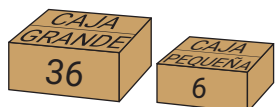

Cinta Métrica De Acero De 5 M X 19mm



605645 **TMT126251**

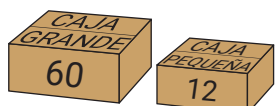

Cinta Métrica (Métrico / Pulgada) Acero De 8 Mts



605646 **TMT126681**



Nivel De Burbuja De 40 Cm

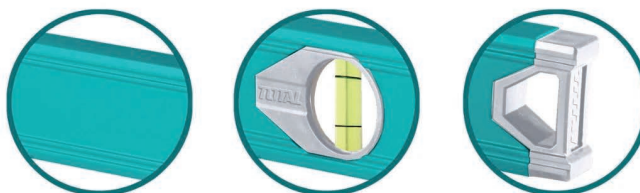

605647

TMT24036



Nivel De Burbuja De 100 Cm

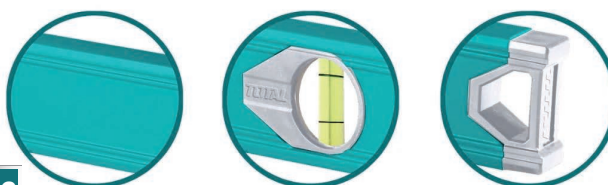

605511

TMT210036



Escuadra Angular De Acero Inoxidable De 300 Mm (12")

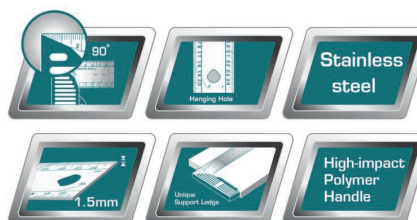
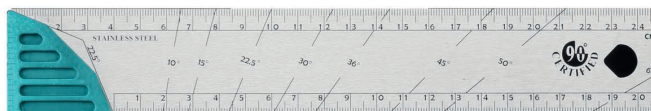

605648

TMT61126



Regla de ángulo digital

605649 **TMT333601**

Rango de medición: 0 - 360o 0 - 200mm / 0 - 400mm (180o)

Lectura: 0.05o 0.1mm / 0.01 "

Batería: 3V

Graduación Métrica

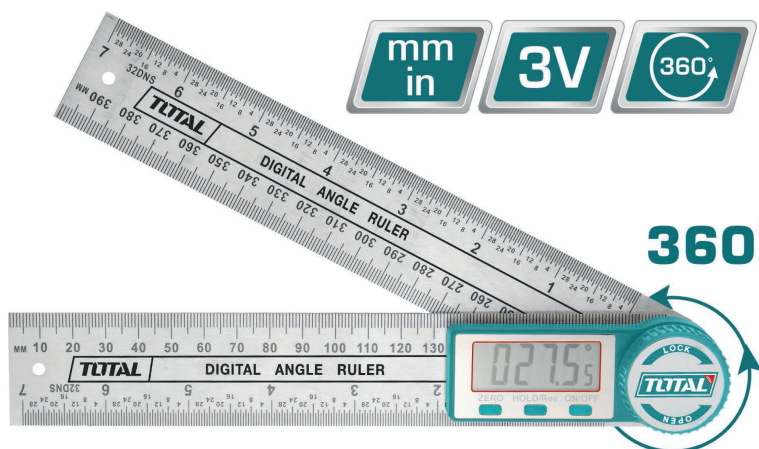
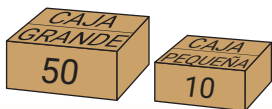

Probador de Corriente Digital

175713 **THT292201**

Voltaje CA: 100-500 V, CC: 12-220 V

Batería No requerido

Largo 135 mm

Ancho 23 mm

Grosor 17 mm

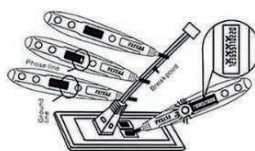
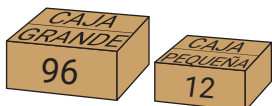

Linterna De Cabeza Max 180 Lm

605413 **THL013AAA2**

Duración h: 4 horas I: 10 horas

Distancia haz de 50m ipx4

Resistente a la lluvia

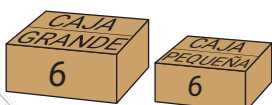

Linterna De Mano Aleación De Aluminio Grado De Aviación 6n01-t6

605641 **TMT126321**

Max: 400 lúmenes
 Medio: 150 lúmenes
 Bajos: 50 lúmenes
 Batería de iones de litio 18650
 Tiempo de ejecución 4h de alta luz
 Tiempo de ejecución de baja luz 18h
 Cuatro interruptores: resaltado, luz media, luz baja
 Diámetro/longitud: 27,5 mm/158,3 mm



CAJA GRANDE 60
 CAJA PEQUEÑA 20

Serrucho Plegable 7"/ 180 Mm



605652 **THFSW1806**

CAJA GRANDE 48
 CAJA PEQUEÑA 6

Candado Bronce Heavyduty 30Mm

605653 **TLK32302**



CAJA GRANDE 144
 CAJA PEQUEÑA 12

Candado Bronce Heavyduty 40 Mm

605654 **TLK32402**



CAJA GRANDE 96
 CAJA PEQUEÑA 12